



MGB Chrome Bumper Conversion

Installation Instructions

For 1974 1/2 - 1980 MGB

PART # 453-878, 453-888

440 Rutherford St. P.O. Box 847 Goleta, CA 93117
1-800-667-7872 • FAX 805-692-2525 • www.mossmotors.com

This kit requires cutting, welding, and painting. Professional installation recommended.

Note: Every MGB body is slightly different and trimming will be necessary to fit the parts to the car.

Tools required: 9/16" and 3/4" sockets, 3/4" combination wrench, long extension, tin snips, sawzall, die grinder with cut-off wheel, cold chisel, file, scribe, 7/64, 5/32, 3/16, 5/16, 21/64, and 3/8" drill bits, electric drill, safety glasses.

1. Lift the whole car up and place on jack stands. Do not work on the car while it's sitting on the jack. Open the hood.

2. Locate the wiring leading to the turn/running lights mounted in the bumper. Disconnect the wiring (three wires on one side and two on the other) where they connect to the harness, near the sides of the radiator. Pay attention to color code.

Illustration 1

Illustration 1



3. Using a 9/16" socket, remove the bolts securing the corner braces to the back of the bumper and to the chassis on both sides. **Illustration 2**



Illustration 2



4. At this time mark where the grill sits over both frame rails with a marker. These will be used as reference lines further in the installation. Remove the grill to access the main bumper mounting nuts. On out '79 MGB there were five screws. **Illustration 3**

Illustration 3



Installation Instructions

Illustration 3 continued



5. Remove the two lower main bumper mounting nuts using a 9/16" socket. Next, remove the upper two nuts. As you remove the upper nuts lean against the bumper to avoid it falling off. Also be aware the shims may be present between the bumper and the car. Remove the bumper by pulling forward. The bumper is fairly heavy and assistance may be required. Guide the wires as the bumper is removed. **Illustration 4**



Illustration 4



6. Trimming of the main bumper mounts (frame rail) is necessary to fit a new grill to the car. Start by marking horizontally at the same level as the radiator opening. This will be a cut line. Now on the top of the frame rail, where you made the marks indicating the grill location, move those

marks rearward 1" to allow space for a full grill. The upper half of the bumper mount will be removed. Use a Sawzall to cut across the front of the mount and a die grinder with a cut-off wheel to cut down the sides. Use a cold chisel to break loose the upper half once you've cut it all the way around. **Illustration 5**



Illustration 5



7. File or grind all the burrs off the exposed end of the frame rail. Then weld in a 1-7/16" X 1-7/8" sheet metal cap to cover the end of the rail.

8. Next, to the turn signal location. The kit includes two sheet metal parts to fill in where the new turn signal will be located. These parts need to be fit to the car and trimmed accordingly. Once the fit is satisfactory, weld the part to the car. **Illustration 6**



Illustration 6

Installation Instructions

Illustration 6 continued

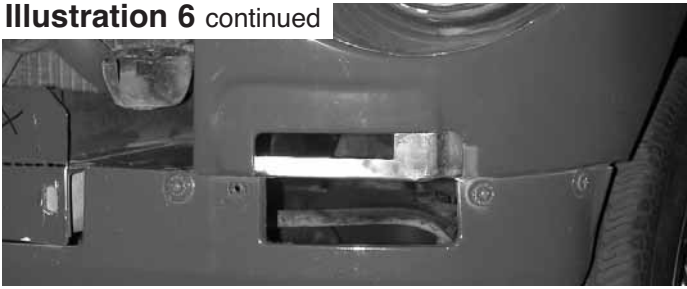

9. With the filler pieces welded into the turn signal holes, they must be cut out to allow the new turn signal to fit. Use the template to locate the light and mark the shapes onto the car. Make sure the template faces the correct way. The round keyhole shape goes toward the outside, and the pointed rectangle "points" toward the middle of the car. Illustration 7 shows the right-hand side of the car. Repeat for the other side. Drill 3/16" holes for the correct two mounting locations for the turn signals. Cut out the other two shapes following the outside of your lines. Use a file to remove any burrs. **Illustration 7**

Illustration 7

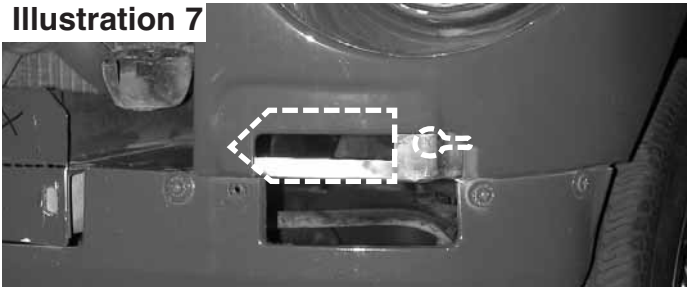

10. The kit includes a new valance that doesn't have holes in it for the corner braces. Remove your old valance. **Illustration 8**

Illustration 8



11. The new valance must be trimmed to fit around the main bumper mounting pads. Use the included template to mark the valance. Use a die grinder and cut off wheel or tin snips to cut out the notch. Remove any burrs with a file. **Illustration 9**

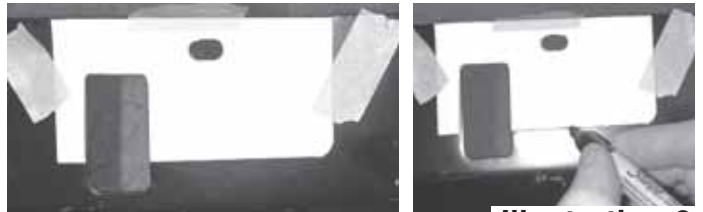

Illustration 9



12. Next, fit the valance to the car. If it fits around the bumper mounting pads, attach it using the two center bolts. (If not, mark, trim, and refit.) Center the bolts in the slots and snug the bolts. **Illustration 10**

Illustration 10

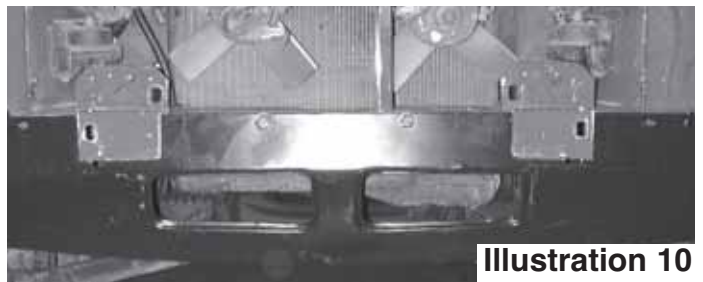

Illustration 10

13. Once the valance is bolted to the car, follow it around to either side putting it into place. The last two mounting holes in the car on the ends will have to be drilled in the new valance. Hold the valance in place and mark the hole locations from the back using a scribe. Mark both holes on both sides. Now, check the other hole locations

Installation Instructions

across the front and mark the covered holes. Remove the valance, center punch the hole locations, and drill using a 5/16" drill bit.

Illustration 11

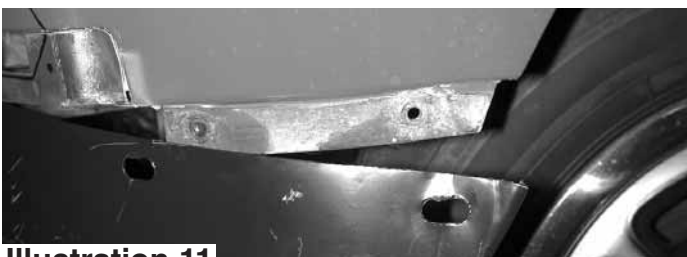

Illustration 11



14. Reinstall the valance and make sure all the holes line up. Fasten the ends in snug and look at the alignment with the fender. If it is not aligned you will have to bend the flange in a different spot. Mark the new bend location on both sides. Remove the valance, carefully pound the flange back flat for about 3" until it blends into the round corner. Bend the flange using your mark. If there is excess width on the flange, trim it back even with the rest of the flange. File any burrs that may exist and reinstall the valance on the car. **Illustration 12**



Illustration 12

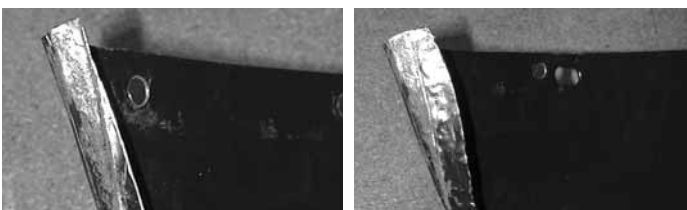

Illustration 12 continued

15. Now, install the new bumper brackets. There is a right and left bracket. The bracket bolt goes through the remaining hole in the bumper, mounting pad. Use the previously removed nuts and washers to secure the bracket to the car. The brackets go down and out to the side. Level the brackets and snug the nuts. Install the bumper on the brackets, adjust the height of the bumper/brackets so that it is even with the body on both sides. Tighten the brackets and remove the bumper. **Illustration 13**

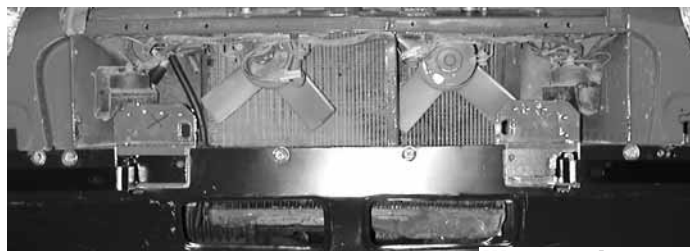

Illustration 13



16. Mark through the remaining hole in the bracket. Remove the bracket and center punch the center of your marks. Drill first with an 1/8" pilot bit and then drill out to 21/64". Reinstall the

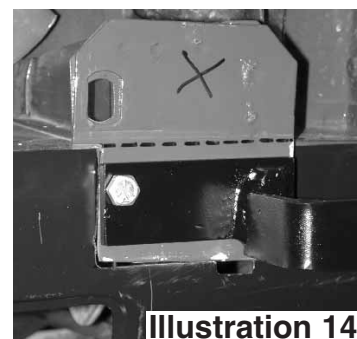

Illustration 14

Installation Instructions

bracket using the included 3/8" sheet metal screw in the new hole. **Illustration 14**

17. Reinstall the bumper and adjust to the correct height. (The bumper may need to be shimmed forward, away from the car. Use factory shims.) Fit the outer bumper brackets onto the bumper. Use a chrome bolt, half round bumper pad, a bracket, a washer and a nut. Just snug the nut for now and rotate the bracket until it correctly matches the valance. Scribe a mark through the welded nut onto the valance. Repeat for the other side. Remove the bumper and gently center punch the center of the marks. Drill a 1/8" pilot hole and then drill it out to 3/8". Reinstall the bumper and connect the corner brackets to the valance using a 3/8"X1-1/4" bolt, lock washer, and flat washer. Use a front over rider as the inner bumper fasteners. Install the rubber strips (over rider packing) on the over rider, then install it on the bumper. After tightening the over rider, trim off the excess packing. **Illustration 15**



Illustration 15

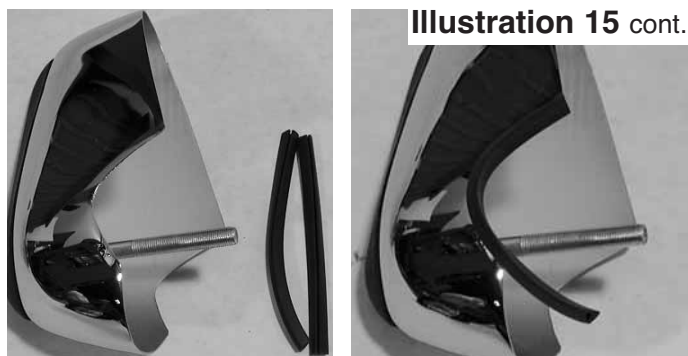
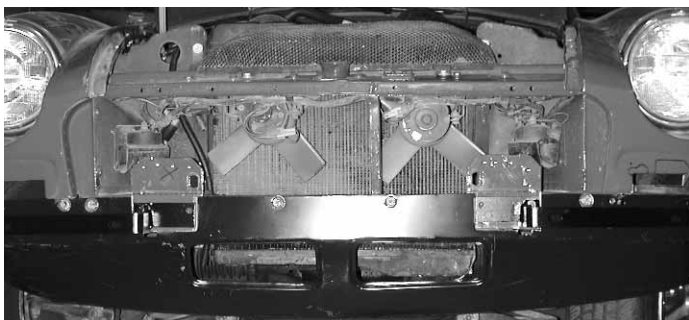
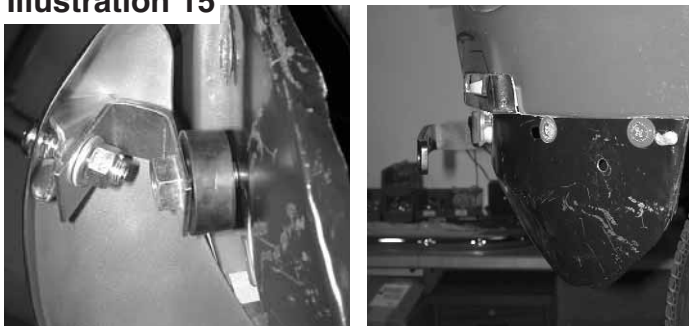
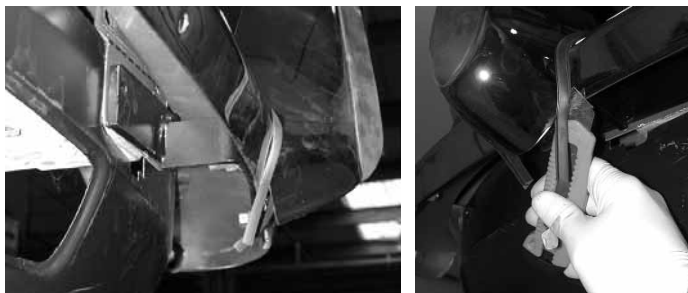

Illustration 15 cont.



18. There are a couple of grill styles to choose from. Common problems regarding grill fit are width (how they fit the body on each side) and how well the arch of the hood fits the grill. First the width. If the grill doesn't slip into the body with clearance on both sides, it will have to be narrowed slightly. Cut a small slit in the end (side) of the grill so that the angle of the end can be flattened slightly. Tap gently with a soft faced hammer until you have changed the taper of the grill. Change both sides of the grill equally until it fits nicely into the opening. Next, lower the hood down to the top of the grill. Check the line between the hood and the grill. They should be parallel to each other. If not, remove the grill and use a block of wood to shape the hood. Most commonly the hood sits on the center of the grill. The hood will need to be arched slightly to match the arch of the grill. Insert the block under the center of the hood and push down gently on the outer edges. Make small adjustments and compare it to the grill until the arches match.

19. Once the grill fits well, set it into the opening and align it so its face is flush with the front of the opening. Mark the lower hole locations. Remove the grill, center punch and drill the lower locations with a 5/32" drill. **Illustration 16**

Installation Instructions

Illustration 16



20. Set the grill back into place and align the lower mounting tabs with the drilled holes. Use the supplied #10X1/2" sheet metal screws to fasten the bottom in place. Leave loose.

21. There are three upper mounting brackets included with the kit. There is a right, center, and left bracket. Start with the center bracket and using a 10-32X 1/2" machine screw, flat washer and nut, fasten the bracket to the car using an existing hole. Repeat for the left and right brackets. **Illustration 17**



Illustration 17

22. Swing the brackets side to side to align with the dimpled hole in the grill surround. Insert a 10-32X5/16" oval head screw into each of the three holes and thread into the brackets. Snug all fasteners.



Illustration 18



Illustration 18

23. Remove the front bumper, the bumper brackets, and the grill. The front is now ready for bodywork and paint.

24. Remove the rear bumper. Our car had five fasteners holding it on. It had two nuts under the car and three in the trunk. Using a 9/16" socket remove the nuts starting with the two underneath the car. Pull straight out on the bumper. Use caution, the bumper is heavy and assistance may be necessary. **Illustration 19**



Illustration 19

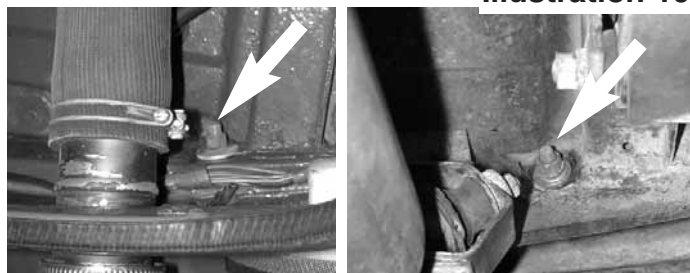

25. Assemble the rear bumper. Attach the spring brackets to the bumper using the rear over riders and packing, two chrome bumper bolts, four 3/8" lock washers and four nuts. Once assembled, trim off the excess over rider packing. **Illustration 20**



Illustration 20



Installation Instructions

26. Next, install the adapter brackets to the rear of the car using the outer two holes in the body. One inside the trunk and one under the car. Use four 7/16"X1" bolts, four flat washers, and four lock nuts. Also, slip one 1/2"X1" bolt through the single slot in the point end of each bracket. Attach the brackets to the car. Note: the head of the 1/2" bolt should be between the body of the car and the bracket. Leave the bolts loose so the bumper can be adjusted. **Illustration 21**



Illustration 21



27. Attach the bumper assembly to the new adapter brackets. Use a 1/2" lock nut to secure the bumper to the car. Snug the nut. **Illustration 22**



Illustration 22

28. Adjust the bumper, side to side and up and down until the fit is pleasing to the eye. Snug all the mounting bolts.

29. Now, fit the corner panels to each side of the car. They should not stick out beyond the taillight and should hang over the bumper slightly. Leave space between the tail light and the corner panel to fit the top piece. Once you are pleased with the fit, remove the tail light from the body and the bumper from the adapter brackets and weld each corner to the car. **Use extreme caution**

when welding around the gas tank. Remove the gas cap and cover the filler neck with tape. Then cover it with a wet rag. Use a piece of sheet metal to shield it from sparks. The tank should be full so that there is less vapor space. Again professional installation is recommended.

Illustration 23

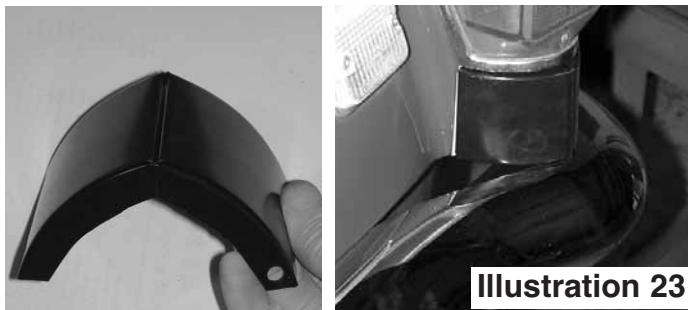

Illustration 23

30. Next, trim, fit, and weld the top and bottom pieces for the corner panels.

31. Reinstall the bumper and adjust as necessary.

32. Install the right and left bumper filler plates. Hold the plate from under the bumper and adjust until the plate fits best. Then mark the holes. Repeat for other side. Remove the bumper and adapter brackets and drill the holes with a 7/64" drill. Use six #6X3/8" sheet metal screws to attach the plates to the car. Reinstall the adapter brackets and the bumper. If all is satisfactory, remove the bumper and brackets from the car and prepare the new areas for paint.

Illustration 24



Illustration 24



Installation Instructions

33. After painting, carefully reinstall the front and rear bumpers. Install the lights in the front and connect them to the same wires that the old lights were connected to. **Illustration 25**



Illustration 25

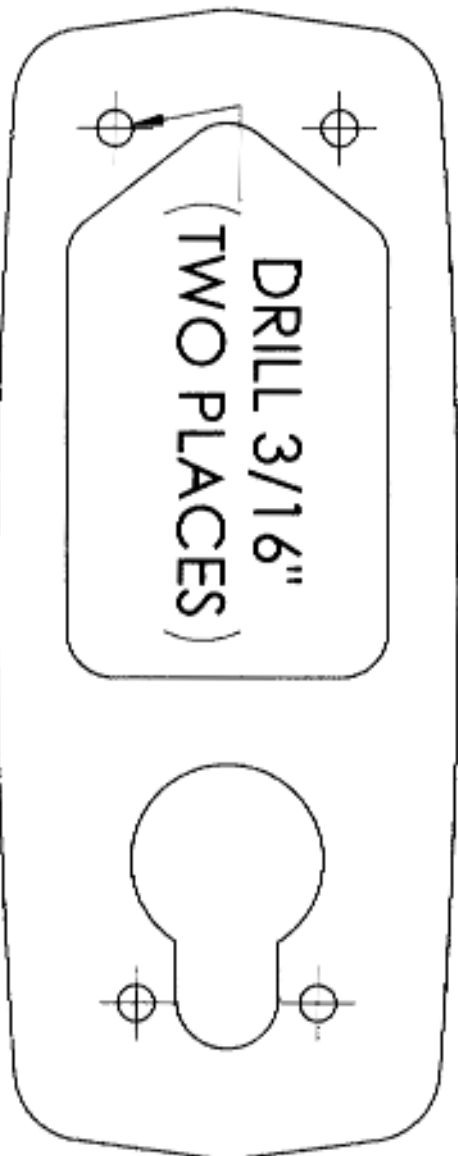
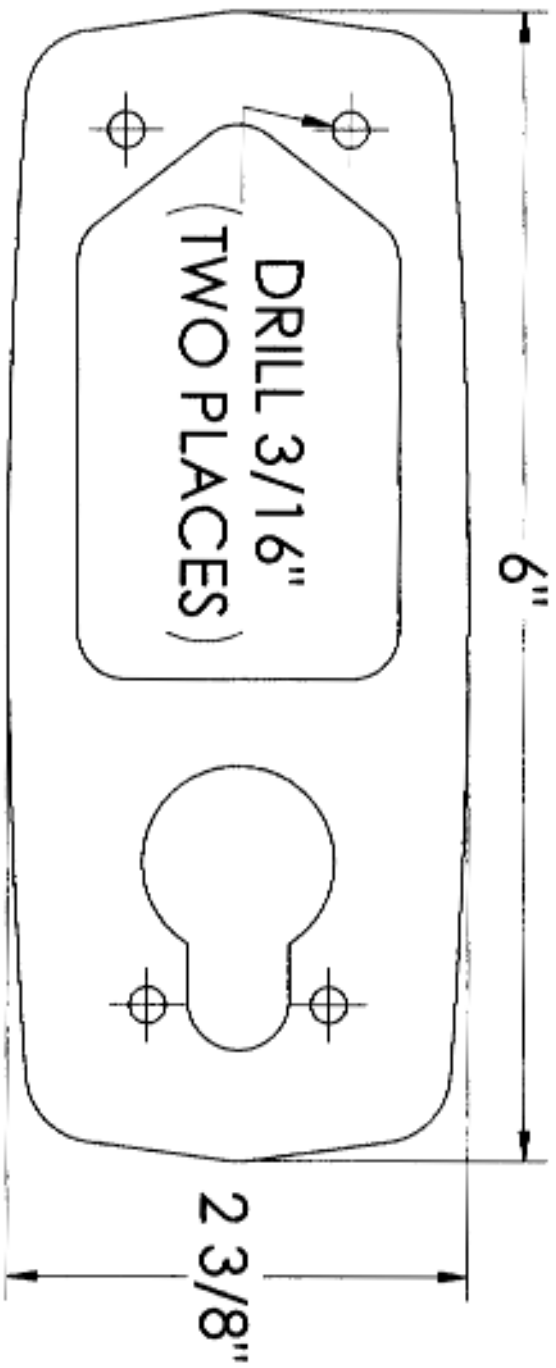

Installation Instructions

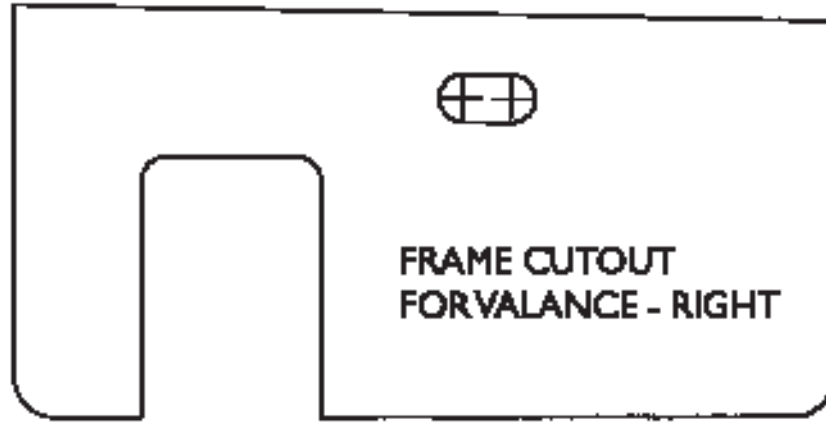
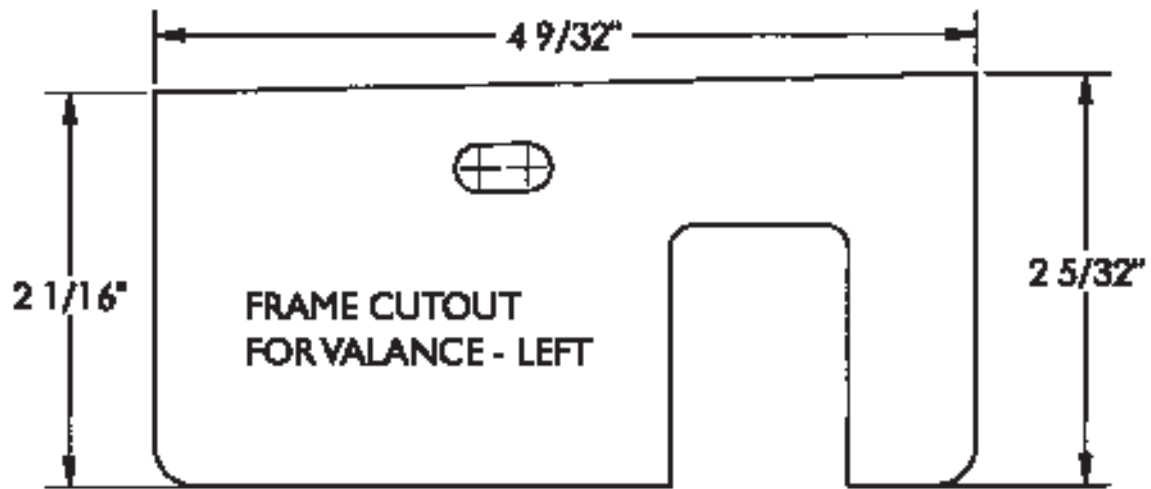

CHECK DIMENSIONS TO VERIFY SIZE